

**SERIES 50 TEMPERED GLASS ANCHOR TABLE**

CONFIG.	FRAME WIDTH	FRAME HEIGHT	NUMBER OF ANCHORS			DESIGN	DESIGN
			ACROSS HEAD & SILL	ACROSS JAMB	ACROSS HOOK STRIP	PRESSURE NEG.	PRESSURE POS.
XX	6'	80.00	10	10	8	-69.22	+50.00
	6'	96.00	10	12	9	-61.47	+50.00
XX	8"	80.00	14	10	8	-50.38	+50.00
	8'	96.00	14	12	9	-50.38	+50.00
XXX	9'	80.00	16	10	8	-63.97	+50.00
	9'	96.00	16	12	9	-57.84	+50.00
XXX	12'	80.00	18	10	8	-50.38	+50.00
	12'	96.00	18	12	9	-50.38	+50.00
XXXX	12'	80.00	18	10	8	-57.16	+50.00
	12'	96.00	18	12	9	-51.03	+50.00
XXXX	16'	80.00	28	10	8	-50.38	+50.00
	16'	96.00	28	12	9	-50.00	+50.00
XXXXXX	18'	80.00	32	10	8	-63.97	+50.00
	18'	96.00	32	12	9	-57.84	+50.00
XXXXXX	24'	80.00	36	10	8	-50.38	+50.00
	24'	96.00	36	12	9	-50.38	+50.00
XXXXXXXX	24	80.00	36	10	8	-57.16	+50.00
	24'	96.00	36	12	9	-51.03	+50.00
XXXXXXXX	32'	80.00	56	10	8	-50.38	+50.00
	32'	96.00	56	12	9	-50.00	+50.00

**ANCHOR DETAILS**

APPLICATION	ANCHOR	EDGE DIST.	MIN. EMBEDMENT	MAX. SHIM SPACE
MASONRY W/1 BY WOOD BUCK	1/4" CONC.	2.0"	1.25"	0.25"
MASONRY W/2 BY WOOD BUCK	#12 WOOD	1.5"	1.50"	0.25"
MASONRY	1/4" CONC.	2.0"	1.25"	0.25"
METAL	#12 SMS	0.75"	.045" (THICK)	0.25"

**NOTES ON ANCHOR CALCULATIONS:**

(1) CALCULATIONS DERIVED FROM TESTED UNIT, TEST REPORT # NCTL-210-3220-1. NCTL-210-3220-1B

(2) TESTED UNIT WAS "XXXX", 192" x 96", USING 1/4" (6mm) TEMPERED GLASS.

(3) THE QUANTITY OF ANCHORS ARE FOR EACH SIDE, NOT TOTAL QUANTITY.

(4) MAX. SPACING AT HEAD OR SILL CORNER IS 6". SPACING IS WITH ANCHORS IN PAIRS

(5) MAX. SPACING AT JAMB CORNER IS 6". SPACING IS WITH ANCHORS IN PAIRS

(6) MAX. SPACING ACROSS HEAD OR SILL IS 16-3/8". SPACING IS WITH ANCHORS IN PAIRS

(7) MAX. SPACING ACROSS JAMBS IS 17". SPACING IS WITH ANCHORS IN PAIRS

(8) MAX. SPACING ACROSS HOOK STRIP IS 11".

**NOTES:**

(1) THIS PRODUCT IS DESIGNED TO COMPLY WITH THE FLORIDA BUILDING CODE 8TH EDITION (2023) INCLUDING HVHZ WHEN PROTECTED BY FIXED, OPERABLE OR PORTABLE SHUTTERS OR SCREENS WHICH HAVE PRODUCT APPROVAL TO RESIST FULL PRESSURIZATION FROM WIND LOADS AS WELL AS LARGE AND SMALL MISSILE IMPACTS AS OUTLINED IN THE HIGH VELOCITY HURRICANE PROVISIONS OF CHAPTER 16.

(2) SHIM AS REQ'D AT EACH SET OF INSTALLATION ANCHORS USING LOAD BEARING SHIMS. MAX. ALLOWABLE SHIM STACK TO BE 1/4". USE SHIMS WHERE SPACE GREATER THAN 1/16" IS PRESENT.

(3) DOOR MATERIAL : 6063-T5 ALUMINUM.

(4) 1/4" DIA. CONCRETE SREW ANCHORS MUST BE OF SUFFICIENT LENGTH TO ACHIEVE A MIN. EMBEDMENT OF 1 1/4" INTO CONCRETE OR MASONRY FOR 1 X WOOD BUCK OR A MIN. EMBEDMENT OF 1 1/4" INTO SOLID WOOD FOR 2 X BUCK OR WOOD FRAMED OPENINGS (GREATER THAN 1 3/8" THICK).

(5) MAX. ALLOWABLE SPACING OF 1/4" DIA. CONCRETE SCREWS, WITHIN 6" FROM EACH CORNER, 16-3/8" ACROSS HEAD & SILL, 17" ALONG JAMBS AND 11" ON HOOK STRIP.

(6) ALL FACTORY APPLIED HOLES IN FRAME MEMBERS NOT DESIGNATED FOR CONCRETE SCREW ANCHORS SHOULD BE FILLED WITH #12 SCREWS OF SUFFICIENT LENGTH TO ACHIEVE A MIN. EMBEDMENT OF 1-1/2" INTO WOOD BUCK.

(7) USE LATEX CAULK OR EQUIVALENT FOR PERIMETER SEAL AROUND EXTERIOR OF DOOR.

(8) WHEN INSTALLING INTO STEEL OR ALUMINUM, #12 SMS MUST HAVE SUFFICIENT LENGTH SO THAT THERE IS FULL THREAD ENGAGEMENT THROUGH THE METAL.

(9) IF EXACT DOOR SIZE IS NOT LISTED IN ANCHOR CHART, USE THE NEXT SIZE LARGER DOOR FOR ANCHOR QUANTY.

(10) FOR POCKET DOOR SIZES, USE CLOSEST BY-PASS DOOR SIZE TO SIZE OF FINISHED OPENING.

(11) GLASS THICKNESS MAY VARY PER ASTM E-1300 GLASS CHART REQUIREMENTS. SINGLE GLAZED SHOWN, INSULATED GLASS ALSO QUALIFIED.

(12) JAMB / SILL CORNERS AND ALL ANCHORS TO BE SEALED WITH SMALL JOINT SEAM SEALANT.

(13) ALL INSTALLATION ANCHORS MUST BE MADE OF A CORROSION RESISTANT MATERIAL OR COATING.

(14) NOT ALL CONFIGURATIONS LISTED ON ANCHOR CHART ARE SHOWN ON THIS DRAWING. HOWEVER, INSTALLATION SECTION A-A & B-B APPLY TO ALL CONFIGURATIONS.

(15) NAMI NUMBER FOR 50R TEMPERED IS N1006690-R3.

WINDOW CRAFTSMEN, INC.  
6031 CLARK CENTER AVE.  
SARASOTA, FLORIDA 34238

TITLE: 50R GLASS SLIDING DOORS  
ALUMINUM BY-PASS/CENTER MEET/POCKET  
WITH TEMPERED GLASS INCL. HVHZ  
ANCHOR TABLE AND NOTES

H	REVISED FOR F.B.C. 8TH ED.	10/13/23	ENGINEER: MARK A. SMITH	DRAWN BY: MAS	DATE: 4/7/11
G	REVISED FOR F.B.C. 7TH ED.	12/4/20	DISCIPLINE: CIVIL	SCALE: N.T.S.	DWG. NO. WCI-SGD011B
F	REVISED FOR F.B.C. 6TH ED.	1/27/18	FL. REG. NO.: 55511	REV. LETTER: H	SHEET 1
E	REVISED FOR F.B.C. 5TH ED.	8/28/16			
D	REVISED FOR CURRENT CODE	6/1/15			
C	REVISED FOR 2010 CODE	2/17/12			
B	REVISED NAMI NUMBER	5/19/11			

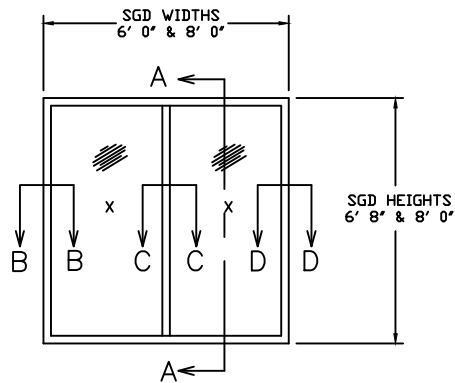

**2 PANEL SLIDING GLASS DOOR  
XX CONFIGURATION**

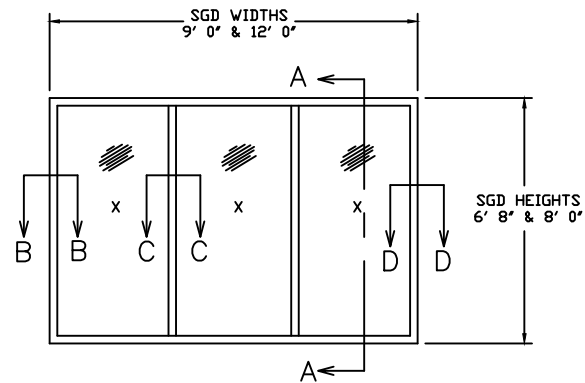

**3 PANEL SLIDING GLASS DOOR  
XXX CONFIGURATION**

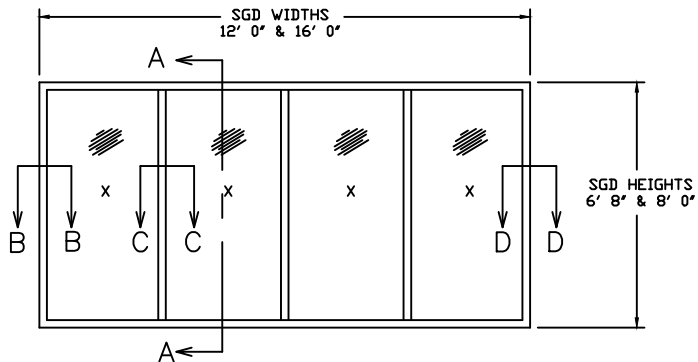

**4 PANEL SLIDING GLASS DOOR  
XXXX CONFIGURATION**

FOR INSTALLATION DETAILS AND  
SECTIONS A-A, B-B, C-C AND D-D SEE SHEETS 4, 5, AND 6

WINDOW CRAFTSMEN, INC. 6031 CLARK CENTER AVE. SARASOTA, FLORIDA 34238		
TITLE: 50R GLASS SLIDING DOORS ALUMINUM BY-PASS/CENTER MEET/POCKET WITH TEMPERED GLASS 2, 3 & 4 PANEL ELEVATIONS		
ENGINEER: MARK A. SMITH	DRAWN BY: MAS	DATE: 12/8/20
DISCIPLINE: CIVIL	SCALE: N.T.S.	DWG. NO. WCI-SGD011
FL. REG. NO.: 55511	REV. LETTER:	SHEET 2

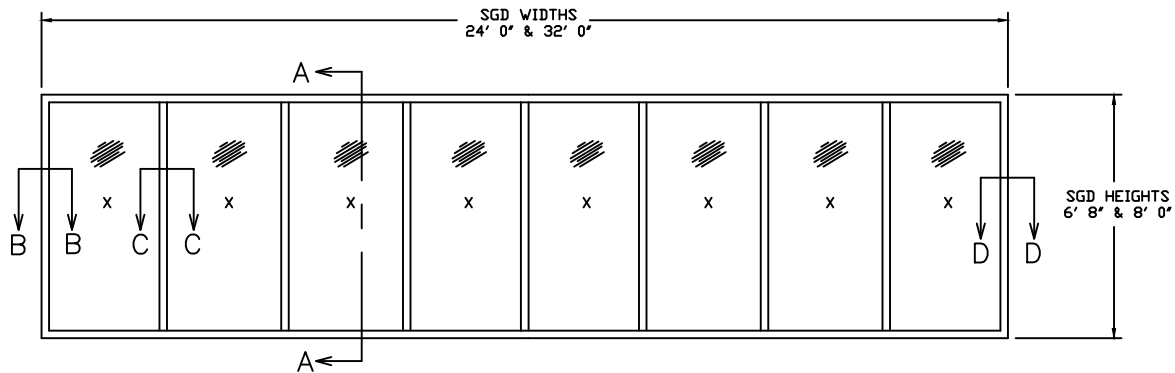
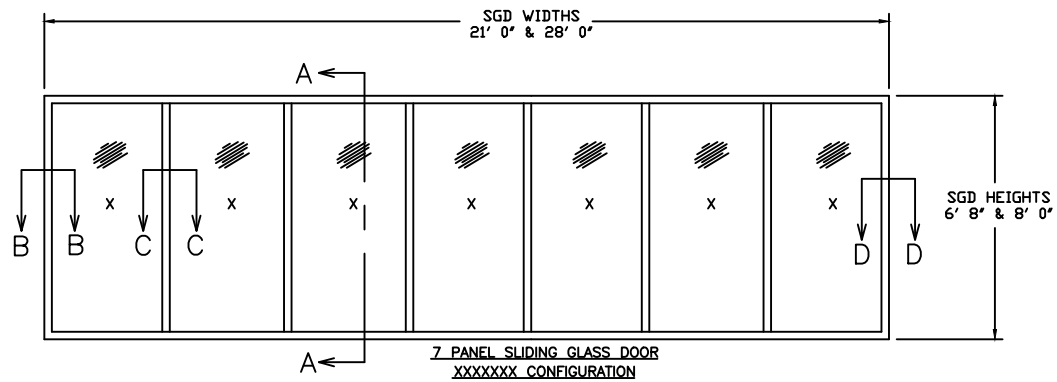
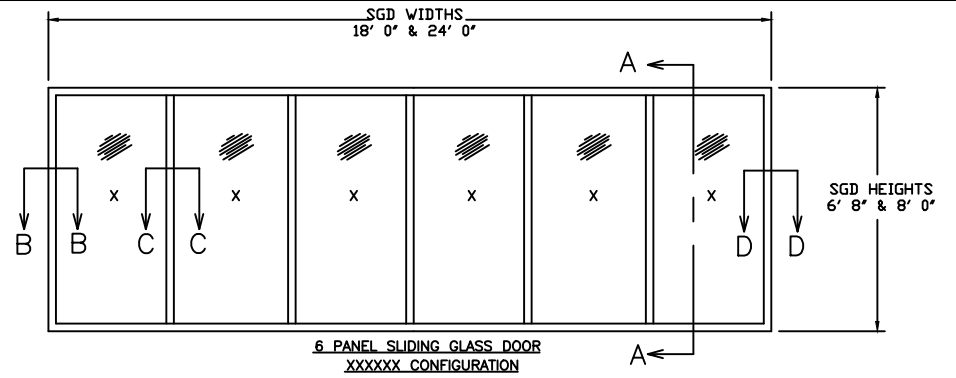
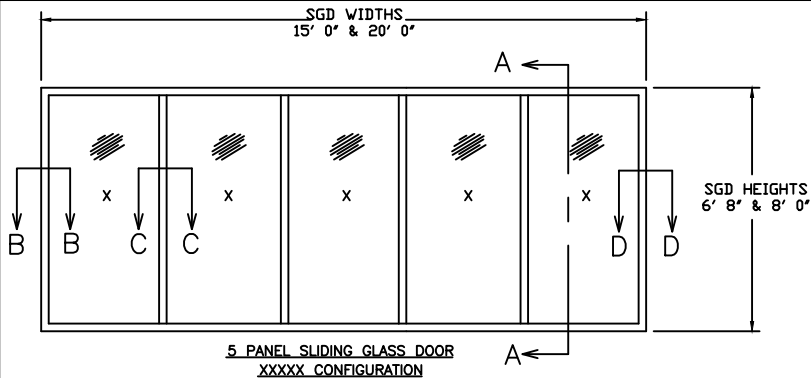

FOR INSTALLATION DETAILS AND  
SECTIONS A-A, B-B, C-C AND D-D SEE SHEETS 4, 5, AND 6

8 PANEL SLIDING GLASS DOOR  
XXXXXXXXX CONFIGURATION

WINDOW CRAFTSMEN, INC. 6031 CLARK CENTER AVE. SARASOTA, FLORIDA 34238		
TITLE: 50R GLASS SLIDING DOORS ALUMINUM BY-PASS/CENTER MEET/POCKET WITH TEMPERED GLASS 5, 6, 7 AND 8 PANEL ELEVATIONS		
ENGINEER: MARK A. SMITH	DRAWN BY: MAS	DATE: 12/8/20
DISCIPLINE: CIVIL	SCALE: N.T.S.	DWG. NO. WCI-SGD011
FL. REG. NO.: 55511	REV. LETTER:	SHEET 3

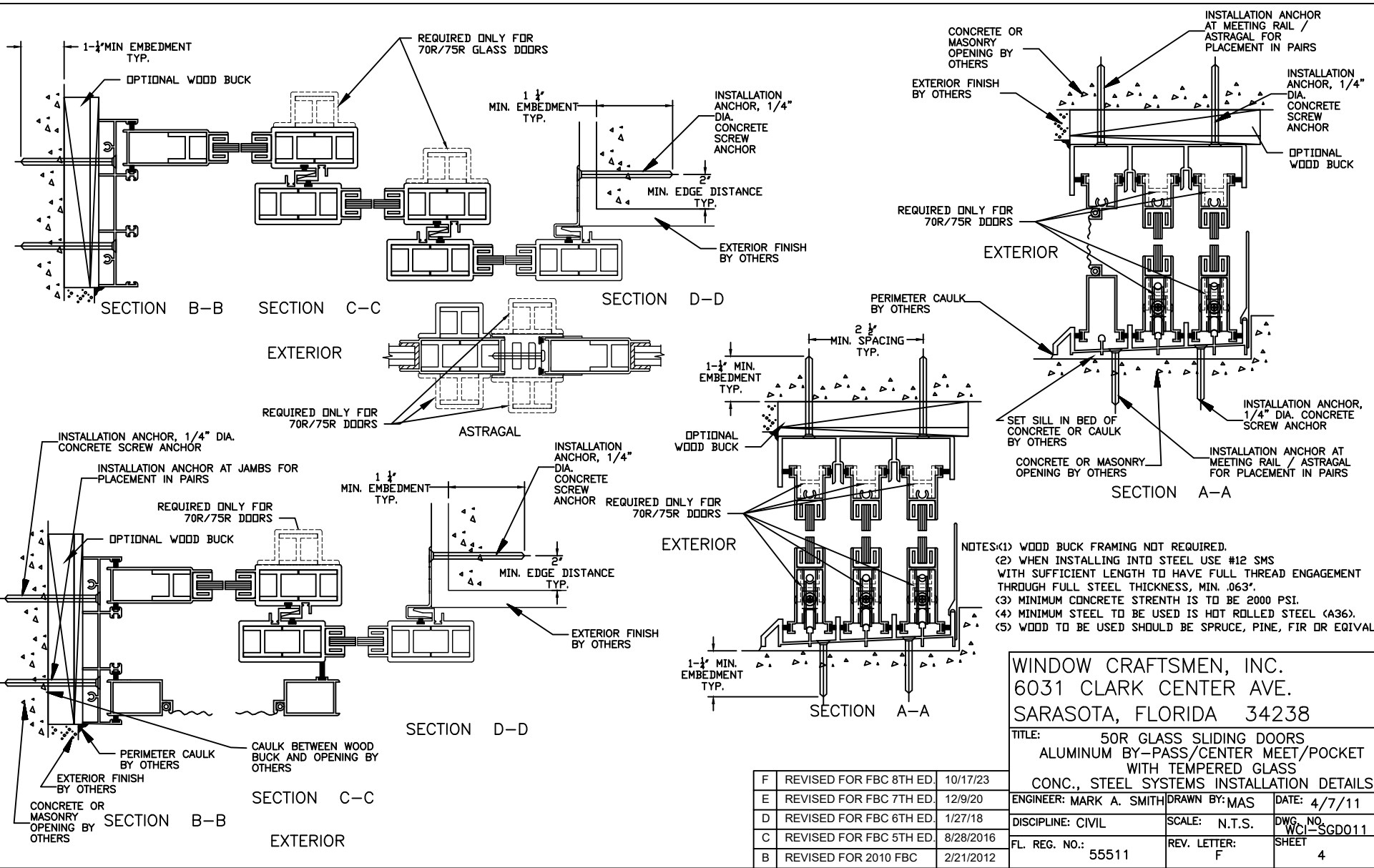

WINDOW CRAFTSMEN, INC.  
 6031 CLARK CENTER AVE.  
 SARASOTA, FLORIDA 34238

TITLE: 50R GLASS SLIDING DOORS  
 ALUMINUM BY-PASS/CENTER MEET/POCKET  
 WITH TEMPERED GLASS  
 CONC., STEEL SYSTEMS INSTALLATION DETAILS

ENGINEER: MARK A. SMITH	DRAWN BY: MAS	DATE: 4/7/11
DISCIPLINE: CIVIL	SCALE: N.T.S.	DWG. NO. WCI-SGD011
FL. REG. NO.: 55511	REV. LETTER: F	SHEET 4

F	REVISED FOR FBC 8TH ED.	10/17/23
E	REVISED FOR FBC 7TH ED.	12/9/20
D	REVISED FOR FBC 6TH ED.	1/27/18
C	REVISED FOR FBC 5TH ED.	8/28/2016
B	REVISED FOR 2010 FBC	2/21/2012

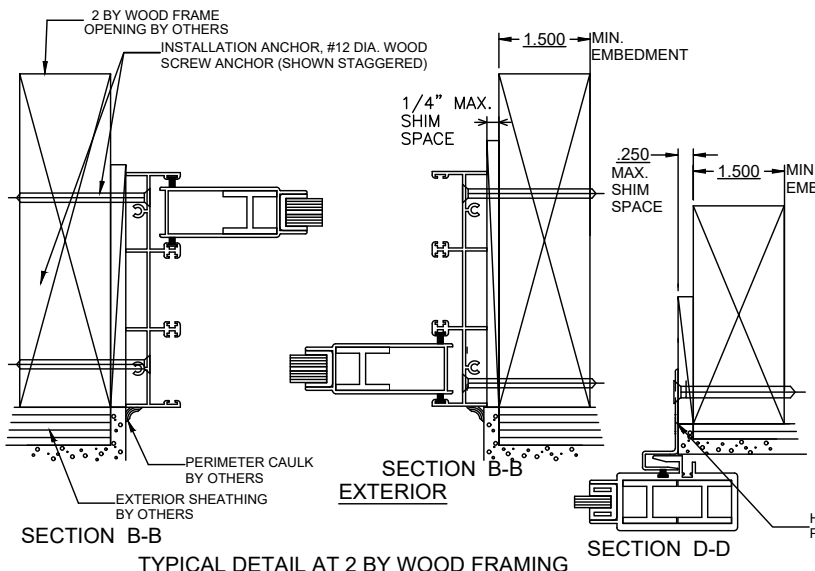

TYPICAL DETAIL AT 2 BY WOOD FRAMING

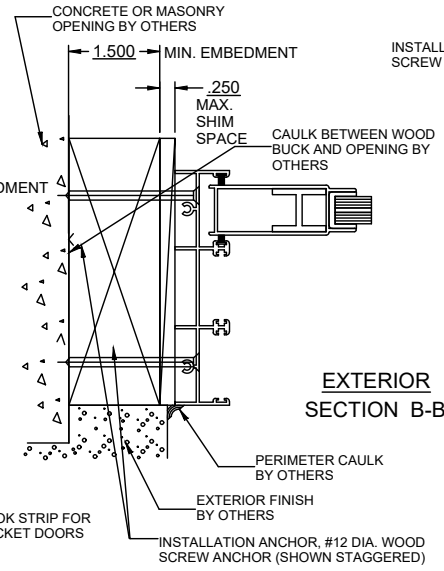

TYPICAL DETAIL AT 2 X BUCK

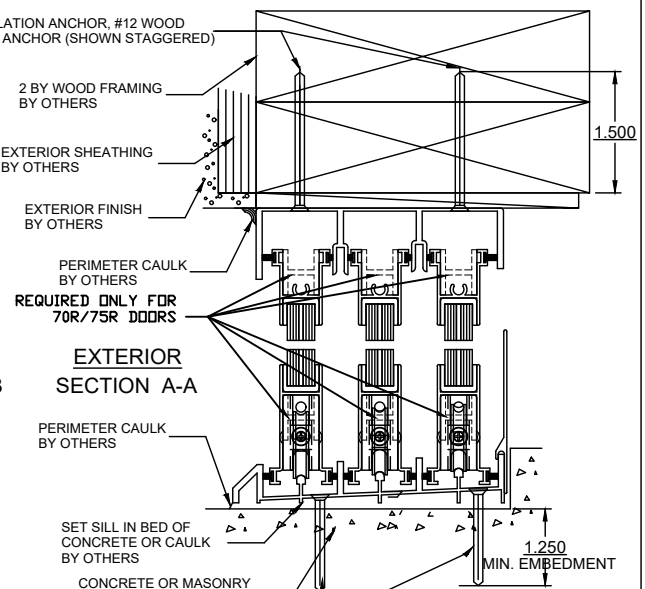

TYPICAL DETAIL AT 2 BY WOOD FRAMING

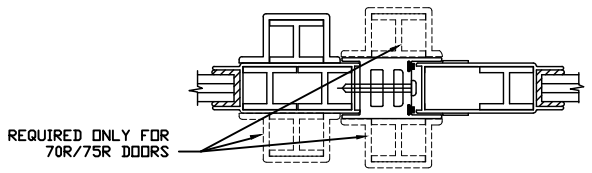

SECTION D-D

SECTION B-B EXTERIOR

SECTION B-B

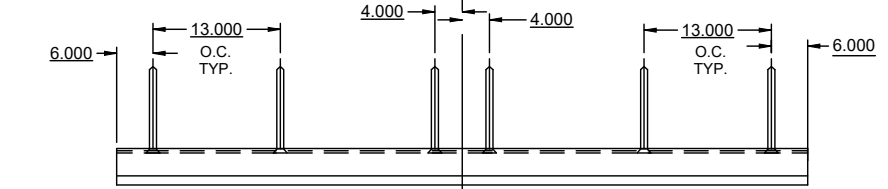
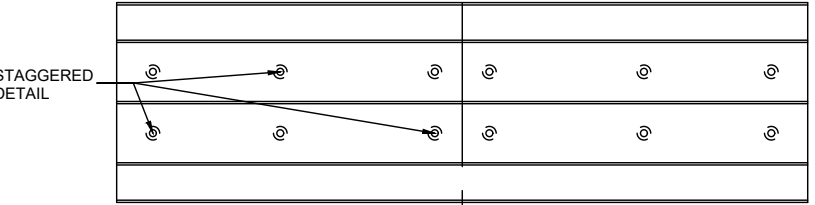

TYPICAL ANCHOR DETAIL AT INTERLOCK OR ASTRAGAL

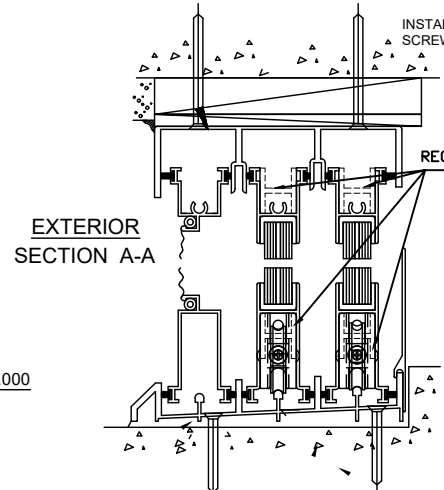

EXTERIOR SECTION A-A

(SHOWN STAGGERED).

REQUIRED ONLY FOR 70R/75R DOORS

- NOTES: (1) WOOD BUCK FRAMING NOT REQUIRED.  
 (2) MINIMUM CONCRETE STRENGTH IS TO BE 2000 PSI.  
 (3) WOOD TO BE USED SHOULD BE SPRUCE, PINE, FIR OR EQUIVALENT.

WINDOW CRAFTSMEN, INC. 6031 CLARK CENTER AVE. SARASOTA, FLORIDA 34238		
TITLE: 50R GLASS SLIDING DOORS ALUMINUM BY-PASS/CENTER MEET/POCKET WITH TEMPERED GLASS WOOD FRAMING INSTALLATION DETAILS		
ENGINEER: MARK A. SMITH	DRAWN BY: MAS	DATE: 4/7/11
DISCIPLINE: CIVIL	SCALE: N.T.S.	DWG. NO. WCI-SGD011
FL. REG. NO.: 55511	REV. LETTER: F	SHEET 5

F	REVISED FOR FBC 8TH ED.	10/17/23
E	REVISED FOR FBC 7TH ED.	12/9/20
D	REVISED FOR FBC 6TH ED.	1/27/18
C	REVISED FOR FBC 5TH ED.	8/28/2016
B	REVISED FOR 2010 FBC	2/21/2012

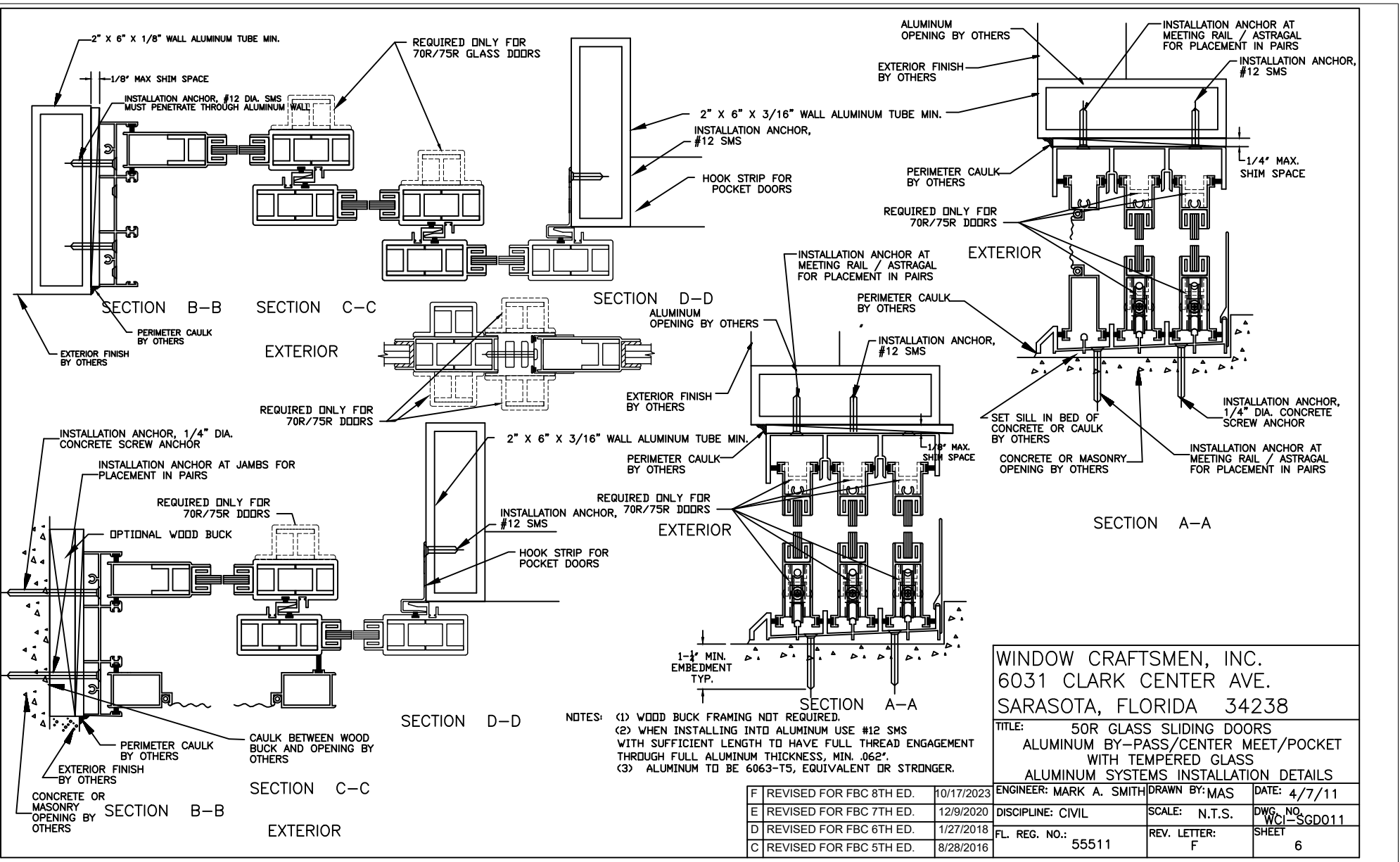

- NOTES:  
 (1) WOOD BUCK FRAMING NOT REQUIRED.  
 (2) WHEN INSTALLING INTO ALUMINUM USE #12 SMS WITH SUFFICIENT LENGTH TO HAVE FULL THREAD ENGAGEMENT THROUGH FULL ALUMINUM THICKNESS, MIN. .062".  
 (3) ALUMINUM TO BE 6063-T5, EQUIVALENT OR STRONGER.

WINDOW CRAFTSMEN, INC.  
 6031 CLARK CENTER AVE.  
 SARASOTA, FLORIDA 34238

TITLE: 50R GLASS SLIDING DOORS ALUMINUM BY-PASS/CENTER MEET/POCKET WITH TEMPERED GLASS ALUMINUM SYSTEMS INSTALLATION DETAILS		
ENGINEER: MARK A. SMITH	DRAWN BY: MAS	DATE: 4/7/11
E REVISOR: 7/11/2020	DISCIPLINE: CIVIL	SCALE: N.T.S.
D REVISOR: 1/27/2018	FL. REG. NO.: 55511	REV. LETTER: F
C REVISOR: 8/28/2016		DWG. NO. WCI-SGD011 SHEET 6

① FOUR TRACK HEAD  
WALL THICKNESS 0.062 TYP.

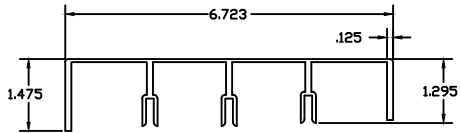

② FOUR TRACK SILL  
WALL THICKNESS 0.078 TYP.

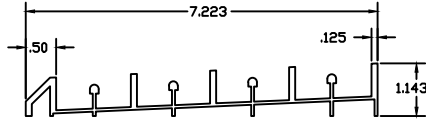

③ FOUR TRACK JAMB  
WALL THICKNESS 0.065 TYP.

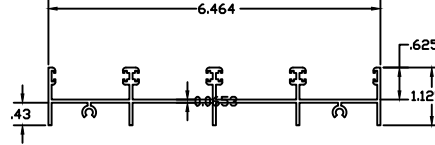

③⁹ ASTRAGAL SCREEN  
WALL THICKNESS 0.060 TYP.

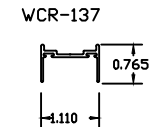

④ THREE TRACK HEAD  
WALL THICKNESS 0.106

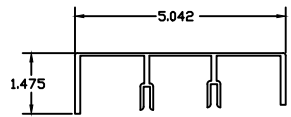

⑤ THREE TRACK SILL  
WALL THICKNESS 0.106 TYP.

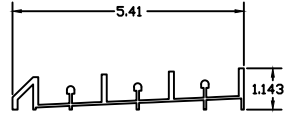

⑥ THREE TRACK JAMB  
WALL THICKNESS 0.053 TYP.

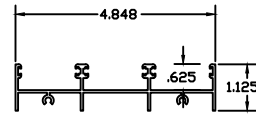

⑦ TWO TRACK HEAD  
WALL THICKNESS 0.132 TYP.

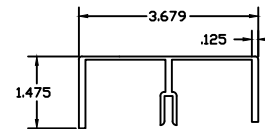

②⁹ INTERLOCK ADAPTER H BAR  
WALL THICKNESS 0.125 TYP.

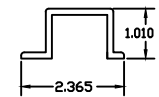

⑧ TWO TRACK SILL  
WALL THICKNESS 0.132 TYP.

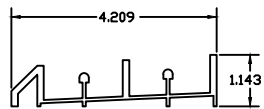

⑨ TWO TRACK JAMB  
WALL THICKNESS 0.066 TYP.

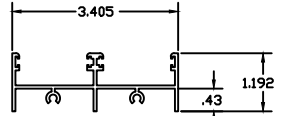

⑩ BOTTOM RAIL  
WALL THICKNESS 0.062 TYP.

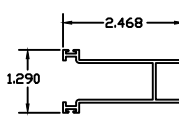

⑪ TOP RAIL  
WALL THICKNESS 0.062 TYP.

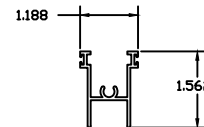

⑫ LOCK STILE  
WALL THICKNESS 0.074 TYP.

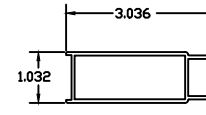

⑬ SINGLE INTERLOCK STILE  
WALL THICKNESS 0.127 TYP.

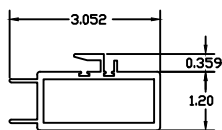

⑭ SILL ADAPTER  
WALL THICKNESS 0.059 TYP.

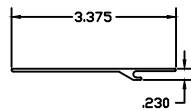

⑮ ASTRAGAL  
WALL THICKNESS 0.075 TYP.

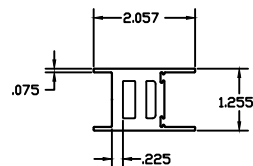

⑯ BOTTOM RAIL/SCREEN  
WALL THICKNESS 0.062 TYP.

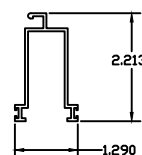

③⁷ LOCK STYLE SCREEN  
WALL THICKNESS 0.062 TYP.

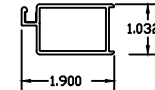

③⁸ VINYL STYLE SCREEN  
WALL THICKNESS 0.062 TYP.

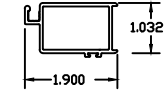

⑰ TOP RAIL/SCREEN  
WALL THICKNESS 0.062 TYP.

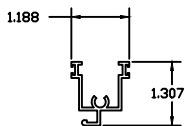

③⁰ H- BAR SUPPORT  
WALL THICKNESS 0.127 TYP.

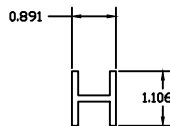

③⁶ H- BAR SUPPORT  
WALL THICKNESS 0.126 TYP.

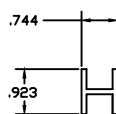

④⁰ HOOK STRIP  
WALL THICKNESS 0.063 TYP.

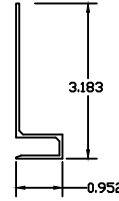

WINDOW CRAFTSMEN, INC.  
6031 CLARK CENTER AVE.  
SARASOTA, FLORIDA 34238

TITLE: 50R GLASS SLIDING DOORS  
ALUMINUM BY-PASS/CENTER MEET/POCKET  
WITH TEMPERED GLASS  
EXTRUSIONS

E	REVISED FOR FBC 8TH ED.	10/17/2022	ENGINEER: MARK A. SMITH	DRAWN BY: MAS	DATE: 4/7/11
D	REVISED FOR FBC 7TH ED.	12/9/2020	DISCIPLINE: CIVIL	SCALE: N.T.S.	DWG. NO. WCI-SGD011
C	REVISED FOR FBC 6TH ED.	1/27/2018	FL. REG. NO.: 55511	REV. LETTER: E	SHEET 7
B	REVISED FOR FBC 5TH ED.	8/28/2016			
A	REVISED FOR 2010 FBC	2/21/2012			

BILL OF MATERIAL

ITEM NO.	PART NO.	DESCRIPTION	VENDOR
1	WCR-90499-1	FOUR TRACK HEAD ALUM. ALLOY 6063-T5	PROFILE
2	WCR-90500-1	FOUR TRACK SILL ALUM. ALLOY 6063-T5	PROFILE
3	WCR-90501	FOUR TRACK JAMB ALUM. ALLOY 6063-T5	PROFILE
4	WCR-79670-1	THREE TRACK HEAD ALUM. ALLOY 6063-T5	PROFILE
5	WCR-79671-1	THREE TRACK SILL ALUM. ALLOY 6063-T5	PROFILE
6	WCR-79672	THREE TRACK JAMB ALUM. ALLOY 6063-T5	PROFILE
7	WCR-90496-1	TWO TRACK HEAD ALUM. ALLOY 6063-T5	PROFILE
8	WCR-90497-1	TWO TRACK SILL ALUM. ALLOY 6063-T5	PROFILE
9	WCR-90498	TWO TRACK JAMB ALUM. ALLOY 6063-T5	PROFILE
10	WCR-90785	BOTTOM RAIL ALUM. ALLOY 6063-T5	PROFILE
11	WCR-91060	TOP RAIL ALUM. ALLOY 6063-T6	PROFILE
12	WCR-110	LOCK STILE ALUM. ALLOY 6063-T6	PROFILE
13	WCR-111	SINGLE INTERLOCK STILE ALUM. ALLOY 6063-T6	PROFILE
14	WCR-112	STILE ADAPTER ALUM. ALLOY 6063-T6	PROFILE
15	WCR-038A	ASTRAGAL ALUM. ALLOY 6063-T5	PROFILE
16	WCR-114	BOTTOM RAIL SCREEN ALUM. ALLOY 6063-T5	PROFILE
17	WCR-115	TOP RAIL SCREEN ALUM. ALLOY 6063-T5	PROFILE
18		SPLINE, 200 ROUND SCREEN	ALUMINUM SPECIALTIES
19	WINCR-1648-01	DOOR LOCK SET	AMERBURY
20		GLASS 1/4" TEMPERED	OLD CASTLE
21	PJS-7623-38	SINGLE ROLLER	SULLIVAN ASSOCIATES
22	FLB229999	DOOR BUMPER	FRANK LOWE RUBBER
23	SGD-1800	PANEL BUMPER	COMMERCIAL PLASTICS
24		#14 X 1", PANEL SCREW -1	ACTION BOLT
25		#14 X 1" TYPE 23, PANEL SCREW-2	ACTION BOLT
26		8-32 X 3/8", KEEPER SCREW	ACTION BOLT
27		#12 X 1-3/4", INSTALLATION/ASTRAGAL SCREW	ACTION BOLT
28		#12 X 1-1/4" SQ. TYPE B, MAINFRAME SCREW	ACTION BOLT
29	WCR-100	INTERLOCK ADAPTER H BAR ALUM. ALLOY 6063-T6	PROFILE
30	WCR-002A	H-BAR SUPPORT ALUM. ALLOY 6063-T5	PROFILE
31	W23251NW	POLYPILE 0.187 X 0.250 FIN	ULTRAFAB
32	W13251NW	POLYPILE 0.187 X 0.250	ULTRAFAB
33	TP-1023	SETTING BLOCK	TEAM PLASTICS
34	TP-433	VINYL GLAZING SCREEN	TEAM PLASTICS
35	TP-915	VINYL INTERLOCK	TEAM PLASTICS
36	WCR-007	H-BAR SUPPORT ALUM. ALLOY 6063-T6	PROFILE
37	WCR-116	LOCK STILE SCREEN	PROFILE
38	WCR-117	VINYL STYLE SCREEN	PROFILE
39	WCR-137	ASTRAGAL SCREEN	PROFILE
40	62490W13	HOOK STRIP	NUAIR
41	TP-162	1/4" MARINE GLAZING	TEAM PLASTICS
42	WC-118	SECURITY CLIP	RIMER & RIMER
43	PD300WHUC-S1	SCREEN HANDLE SET	SULLIVAN ASSOCIATES
44	2537-SS	KEEPER	SULLIVAN ASSOCIATES

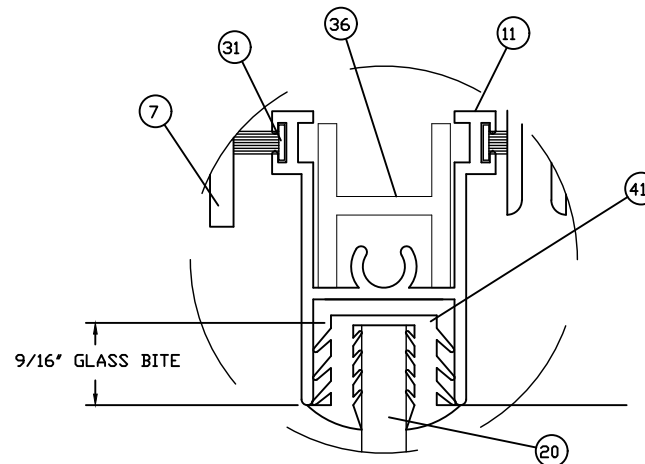

GLAZING DETAIL A

WINDOW CRAFTSMEN, INC.  
6031 CLARK CENTER AVE.  
SARASOTA, FLORIDA 34238

TITLE: 50R GLASS SLIDING DOORS  
ALUMINUM BY-PASS/CENTER MEET/POCKET  
WITH TEMPERED GLASS  
BILL OF MATERIALS

E	REVISED FOR FBC 8TH ED.	10/17/2023	ENGINEER: MARK A. SMITH	DRAWN BY: MAS	DATE: 4/7/11
D	REVISED FOR FBC 7TH ED.	2/9/2020	DISCIPLINE: CIVIL	SCALE: N.T.S.	DWG. NO. WCI-SGD011
C	REVISED FOR FBC 6TH ED.	1/27/2018	FL. REG. NO.: 55511	REV. LETTER: E	SHEET 8
B	REVISED FOR FBC 5TH ED.	8/28/2016			
A	REVISED FOR 2010 FBC	2/21/2012			